

NEW

Proximity Sensor with All-stainless Housing
E2EF



A Metal Head That's
Highly Durable*
and Provides
Long-distance Detection

Standard Model
(Completely stainless-steel
housing)



Spatter-resistant Model
(Completely stainless-steel housing
with Fluororesin Coating)

Long-distance
detection of **7 mm**
(M18 Model)



*More than 20 times the durability of Proximity Sensors with Resin Heads.



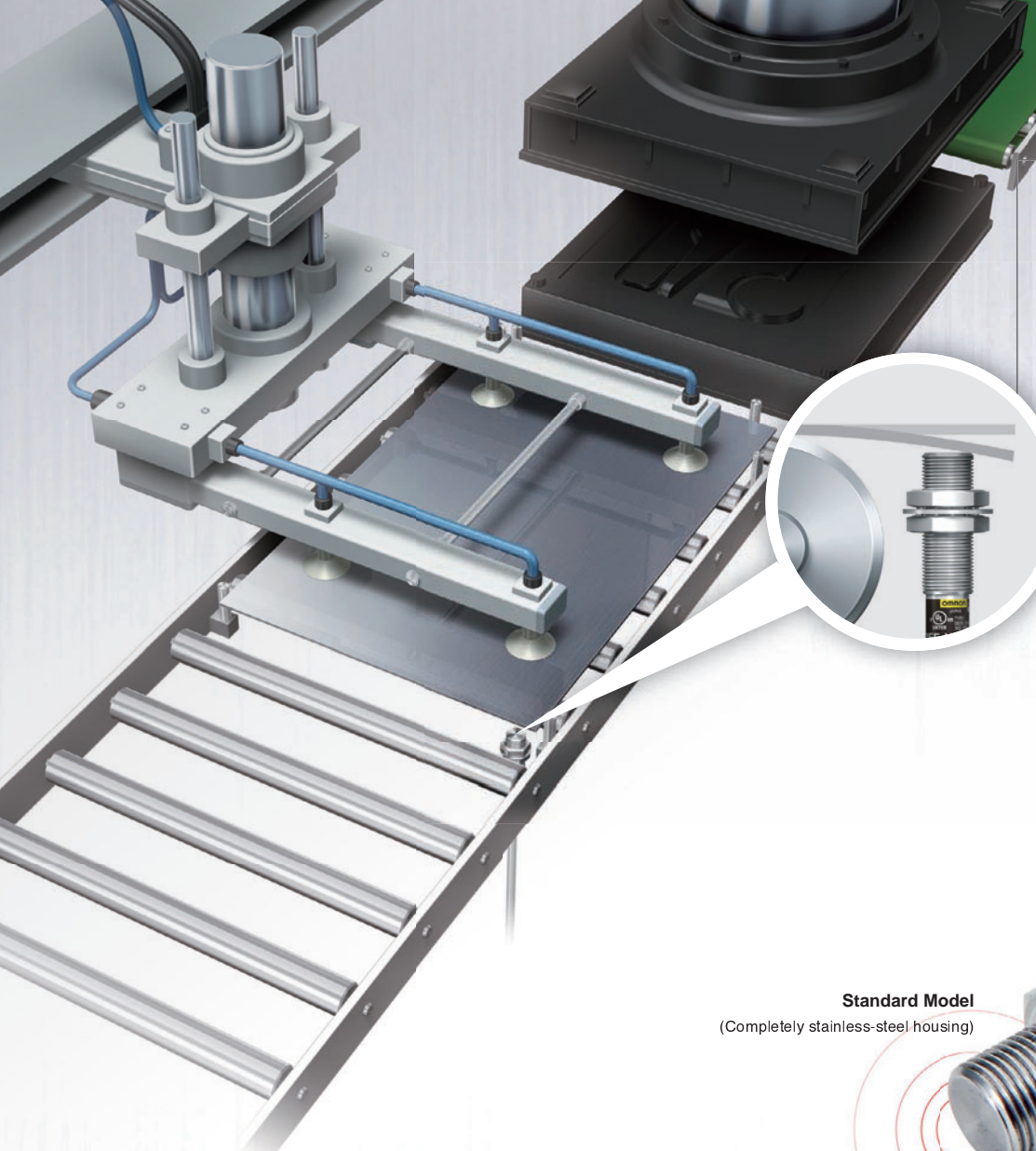

The Problem with Resin Heads

A resin head presents the risk of being damaged due to friction when the sensing surface comes in contact with a warped workpiece when confirming mounting status while the workpiece is moved between processes.

Solved by the E2EF!



Standard Model
(Completely stainless-steel housing)



Long-distance Detection*¹ Equivalent to or Greater Than Proximity Sensors with Resin Heads

Installation is possible at the same distance as Proximity Sensors with Resin Heads.

The metal heads of the E2EF achieve the same distances for the same sizes as the E2E Proximity Sensors with Resin Heads. This allows you to use Proximity Sensors that withstand friction with the workpiece without major changes to mounting brackets.

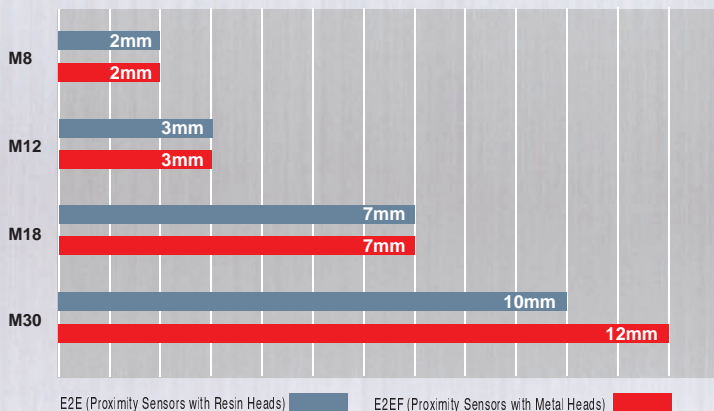

*1: The actual sensing distance will vary with the size or material of the object. For details, refer to Engineering Data.

More than 20 times*² the durability of Proximity Sensors with Resin Heads.

Thick Metal Head That Resists Friction with the Workpiece

Head thickness 0.4 mm *³

The 0.4-mm*³ metal head exhibits almost no wear due to friction with the workpiece or cleaning with metal brushes. This helps prevent equipment down time due to sensor failure and reduces the frequency of replacement.

*2: Stainless-steel brush test with M12 model.

*3: For M12 model.

0.4mm*³ Cross-section



Brush Test*

	Initial state	After 10 min.	After 200 min.
E2E (Proximity Sensors with Resin Heads)			Insulation destroyed in 10 min.
E2EF (Proximity Sensors with Metal Heads)			

*Test results for stainless-steel brush rotating at 130 rpm.

Withstands Harsh Environments with Long-distance Detection and Resistance to Wear.

Reduce the replacement frequency due to damage from friction with the workpiece, prevent equipment down time for sensor failure, and reduce maintenance management costs.



Spatter-resistant Model
(Completely stainless-steel housing with Fluororesin Coating)

For Harsh Environments with High Risk of Workpiece Collision:

A Tough Metal Head That Resists Wear and Strikes

Head thickness
0.8 mm
*4

Proximity Sensor with All-stainless Housing
E2FM

A datasheet is available
(Cat. No. D103-E1-02).

*4:For M12 model.



(UL is not applicable to all models.)

Stable Detection in Harsh Environments with Splatter Resistance and Durability

Spatter-resistant models with fluororesin-coated head are also available.Reduces adhesion of spatter to achieve stable detection.The tough all-stainless steel housing with a flame-retardant cable enables reliable application where spatter is present near welding machines.



Certified for UL

Reduced Cleaning Frequency with Spatter Countermeasures

The spatter countermeasures reduce the risk of malfunction due to the buildup of metal debris or spatter. Frequent cleaning with metal brushes is not required.





E2EF

Ordering Information



Sensors

Standard Models (Completely stainless-steel housing)

Connection method	Appearance	Sensing distance	Output	Operation mode	Model	
Pre-wired Models (2m)		M8	2mm	DC 2-Wire (polarity)	NO	E2EF-X2D1 2M
		M12	3mm			E2EF-X3D1 2M
		M18	7mm			E2EF-X7D1 2M
		M30	12mm			E2EF-X12D1 2M
Pre-wired Smartclick Connector Models (M12)		M8	2mm			E2EF-X2D1-M1TGJ 0.3M
		M12	3mm			E2EF-X3D1-M1TGJ 0.3M
		M18	7mm			E2EF-X7D1-M1TGJ 0.3M
		M30	12mm			E2EF-X12D1-M1TGJ 0.3M

Spatter-resistant Models

(Completely stainless-steel housing with fluororesin coating)

Connection method	Appearance	Sensing distance	Output	Operation mode	Model	
Pre-wired Models (2m)		M8	2mm	DC 2-Wire (polarity)	NO	E2EF-QX2D1 2M
		M12	3mm			E2EF-QX3D1 2M
		M18	7mm			E2EF-QX7D1 2M
		M30	12mm			E2EF-QX12D1 2M
Pre-wired Smartclick Connector Models (M12)		M8	2mm			E2EF-QX2D1-M1TGJ 0.3M
		M12	3mm			E2EF-QX3D1-M1TGJ 0.3M
		M18	7mm			E2EF-QX7D1-M1TGJ 0.3M
		M30	12mm			E2EF-QX12D1-M1TGJ 0.3M

* Vinyl chloride is used for the cable material, and separate protection is required.

Accessories (Order Separately)

Sensor I/O Connectors

Smart Click Connectors

Cable connection direction	Cable specifications	Cable length	No. of cable conductors	Model	Applicable Proximity Sensor model number
Straight 	Flame-retardant, flexible cable	2m	4	XS5F-D421-D80-F	E2EF-X□D1-M1TGJ
		5m	4	XS5F-D421-G80-F	E2EF-QX□D1-M1TGJ

Ratings and Specifications

Item	Size Shielded	M8		M12		M18		M30	
		Shielded							
		Completely stainless-steel housing	Fluororesin coating	Completely stainless-steel housing	Fluororesin coating	Completely stainless-steel housing	Fluororesin coating	Completely stainless-steel housing	Fluororesin coating
Model		E2EF-X2D1 (-M1TGJ)	E2EF-QX2D1 (-M1TGJ)	E2EF-X3D1 (-M1TGJ)	E2EF-QX3D1 (-M1TGJ)	E2EF-X7D1 (-M1TGJ)	E2EF-QX7D1 (-M1TGJ)	E2EF-X12D1 (-M1TGJ)	E2EF-QX12D1 (-M1TGJ)
Sensing distance		2mm±10%		3mm±10%		7mm±10%		12mm±10%	
Set distance		0 to 1.4 mm		0 to 2.1mm		0 to 4.9mm		0 to 8.4mm	
Differential travel		15% max. of sensing distance							
Sensing object		Ferrous metal (The sensing distance decreases with non-ferrous metal. Refer to Engineering Data on page 6.)							
Standard sensing object		Iron, 12 × 12 × 1 mm		Iron, 12 × 12 × 1 mm		Iron, 30 × 30 × 1 mm		Iron, 54 × 54 × 1 mm	
Response frequency *1		200Hz		80Hz		100Hz		50Hz	
Power supply voltage		10 to 30 VDC, ripple (p-p) : 10% max.							
Leakage current		0.8 mA max.							
Output configuration		With polarity							
Control output	Switching capacity	3 to 100 mA							
	Residual voltage	3 V max.(Load current : 100 mA max., Cable length : 2 m)							
Indicators		Operation indicator (red LED), Setting indicator (green LED)							
Operation mode (with sensing object approaching)		NO(normally open)							
Protection circuits		Surge suppressor, Load short-circuit protection							
Ambient temperature range		Operating : -10 to 70°C, Storage : -25 to 70°C (with no icing or condensation)							
Ambient humidity range		Operating/Storage : 35% to 95% (with no condensation)							
Temperature influence		±20% max. of sensing distance at 23°C in the temperature range of -10 to 70°C.							
Voltage influence		±1% max. of sensing distance at rated voltage in the rated voltage ±15% range							
Insulation resistance		50 MΩ min. (at 500 VDC) between current-carrying parts and case							
Dielectric strength		1,000 VAC, 50/60 Hz for 1 minute between current-carrying parts and case							
Vibration resistance		Destruction : 10 to 55 Hz, 1.5-mm double amplitude for 2 hours each in X, Y, and Z directions							
Shock resistance		Destruction : 500 m/s ² 10 times each in X, Y, and Z directions		Destruction : 1,000 m/s ² 10 times each in X, Y, and Z directions					
Degree of protection		IEC 60529 IP67							
Connection method		Unmarked : Pre-wired Models (Standard cable length : 2 m) Models ending with -M1TGJ : Pre-wired Connector Models (Standard cable length : 300 mm)							
Weight (packed state)	Pre-wired Models (2 m)	Approx. 105 g		Approx. 190 g		Approx. 215 g		Approx. 295 g	
	Pre-wired Connector Models	Approx. 65 g		Approx. 85 g		Approx. 110 g		Approx. 190 g	
Materials	Case	Stainless steel (SUS303) (E2EF-QX□ : Fluororesin coating)							
	Sensing surface (thickness)	Stainless steel (SUS303) (E2EF-QX□ : Fluororesin coating) 0.2mm		0.4mm		0.4mm		0.5mm	
	Clamping nuts	Stainless steel (SUS303) (E2EF-QX□ : Fluororesin coating)							
	Toothed washer	Zinc-plated iron							
	Cable	PVC (flame retardant)							
Accessories		Instruction manual							

*1. The response frequency of the DC switching section is an average value. Measurement conditions are as follows: standard sensing object, a distance of twice the standard sensing object, and a set distance of half the sensing distance.

I/O Circuit Diagrams

Operation mode	Model	Timing chart	Output circuit
NO	E2EF-(Q)X□D1 (-M1TGJ)	<p>The timing chart shows a sensing object moving through three areas: Non-sensing area, Unstable sensing area, and Stable sensing area. The 'Set position' is marked at the start of the stable area. The x-axis represents distance in % (0 to 100). The y-axis shows the state of three outputs: Setting indicator (green), Operation indicator (red), and Control output. The Setting indicator turns ON at the start of the stable area and OFF at the end. The Operation indicator turns ON at the start of the stable area and OFF at the end. The Control output turns ON at the start of the stable area and OFF at the end. The rated sensing distance is indicated as 70(TYP) %.</p>	<p>The output circuit diagram shows a proximity sensor main circuit connected to a load. The load is connected between the Brown pin (1) and the Blue pin (4). The Blue pin (4) is connected to 0V. The power supply voltage is 10 to 30 VDC. The connector pin arrangement for -M1TGJ is shown as a 4-pin circular connector with pins 1, 2, 3, and 4. Note: Pins 2 and 3 are not used.</p>

E2EF

Engineering Data (Reference Value)

Sensing Area

E2EF-X□
-QX□

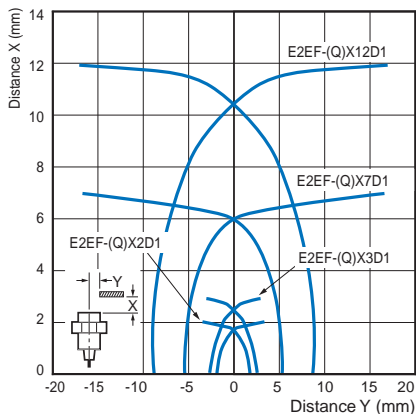

Influence of Sensing Object Size and Material

E2EF-X2D1
-QX2D1

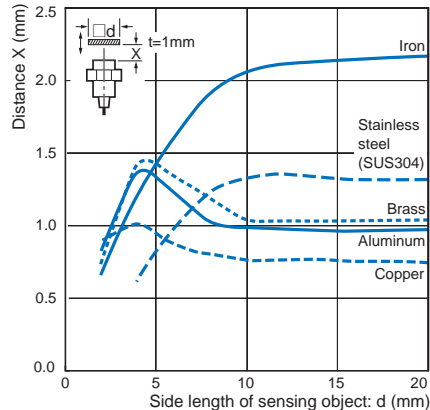

E2EF-X3D1
-QX3D1

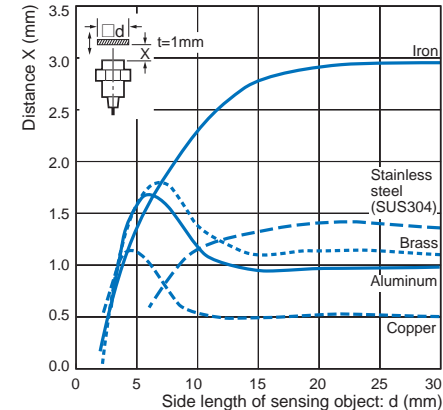

E2EF-X7D1
-QX7D1

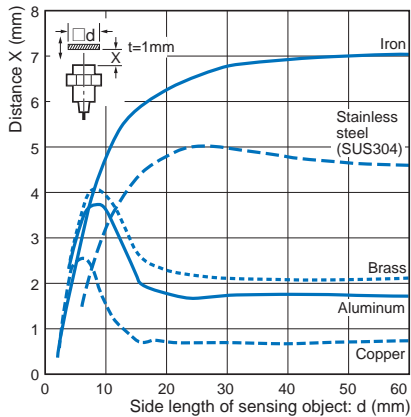

E2EF-X12D1
-QX12D1

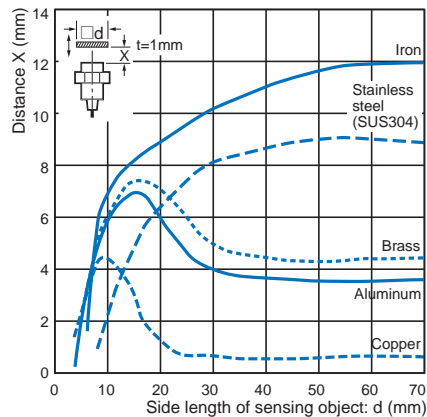

Leakage Current

E2EF-X□D1

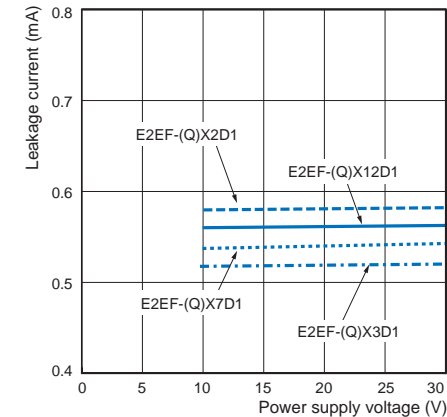

Residual Output Voltage

E2EF-X□D1
-QX□D1

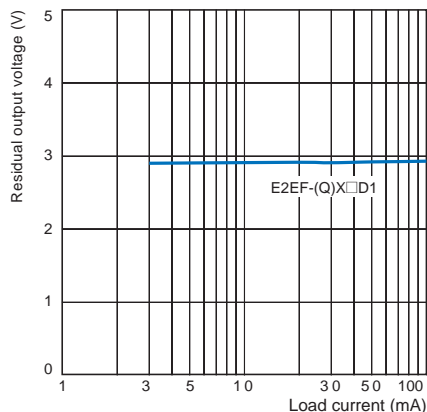

Safety Precautions

⚠ WARNING

This product is not designed or rated for ensuring safety of persons either directly or indirectly. Do not use it for such purposes.



Never use this product with an AC power supply. Otherwise, explosion may result.



Precautions for Safe Use

The following precautions must be observed to ensure safe operation.

- Do not use the Sensor in an environment where inflammable or explosive gas is present.
- Do not attempt to disassemble, repair, or modify any Sensors.
- Power Supply Voltage
Do not use a voltage that exceeds the rated operating voltage range. Applying a voltage that is higher than the operating voltage range may result in explosion or fire.
- Incorrect Wiring
Be sure that the power supply polarity and other wiring is correct. Incorrect wiring may cause explosion or fire.
- Connection without a Load
If the power supply is connected directly without a load, the internal elements may explode or burn. Be sure to insert a load when connecting the power supply.

Precautions for Correct Use

Do not use the Sensor under ambient conditions that exceed the ratings.

- Do not use the Sensor in the following locations.
 - Outdoor locations directly subject to sunlight, rain, snow, or water droplets
 - Locations subject to atmospheres with chemical vapors, in particular solvents and acids
 - Locations subject to corrosive gas
- The Sensor may malfunction if used near ultrasonic cleaning equipment, high-frequency equipment, transceivers, cellular phones, inverters, or other devices that generate a high-frequency electric field. Refer to the OMRON website (www.ia.omron.com/) for typical measures.
- Laying the Sensor wiring in the same conduit or duct as high-voltage wires or power lines may result in incorrect operation and damage due to induction. Wire the Sensor using a separate conduit or independent conduit.
- Cleaning
Never use thinner or other solvents. Otherwise, the Sensor surface may be dissolved.

● Design

Influence of Surrounding Metal

When the Proximity Sensor is embedded in metal, make sure that the clearances given in the following table are maintained. The values depend on the type of nuts used for mounting. Be sure to use the supplied nuts (SUS303).

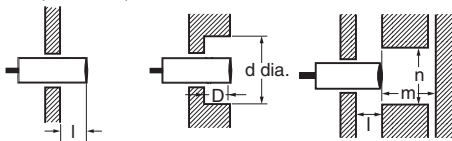

(Unit: mm)

Model	Item Embedding material	l	d	D	m	n
E2EF-(Q)X2D1	Iron	0	8	0	8	30
	Aluminum	10	50	10	8	50
E2EF-(Q)X3D1	Iron	0	12	0	12	40
	Aluminum	16	70	16	12	70
E2EF-(Q)X7D1	Iron	0	18	0	28	60
	Aluminum	16	80	16	28	80
E2EF-(Q)X12D1	Iron	0	30	0	48	100
	Aluminum	24	120	24	48	120

Note: The influence from other non-magnetic surrounding metals is nearly the same as that from aluminum.

Mutual Interference

When installing two or more Sensors face-to-face or side-by-side, ensure that the minimum distances given in the following table are maintained.

(Unit: mm)

Model	Item	A	B
E2EF-(Q)X2D1		35	35
E2EF-(Q)X3D1		40	35
E2EF-(Q)X7D1		65	60
E2EF-(Q)X12D1		110	100

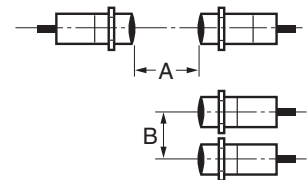

Chips from Cutting Aluminum

Normally, chips from cutting aluminum will not cause a detection signal to be output even if it adheres to or accumulates on the detection surface. In the following cases, however, a detection signal may be output. Remove the cutting chips in these cases.

- If $d \geq \frac{2}{3} D$ at the center of the detection surface where d is the cutting chip size and D is the detection surface size

(Unit: mm)

Model	Dimension	D
E2EF-(Q)X2D1		6
E2EF-(Q)X3D1		10
E2EF-(Q)X7D1		16
E2EF-(Q)X12D1		28

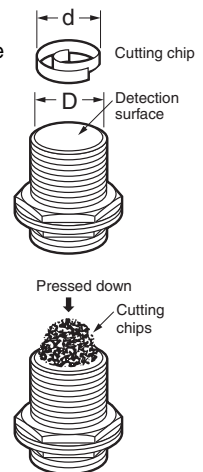

- If the cutting chips are pressed down

● Mounting

Do not tighten the nut with excessive force. A washer must be used with the nut. Do not use tightening force that exceeds the values in the following table.

Model	Torque
E2EF-(Q)X2D1	9 N·m
E2EF-(Q)X3D1	30 N·m
E2EF-(Q)X7D1	70 N·m
E2EF-(Q)X12D1	180 N·m



E2EF

Dimensions

(Unit: mm)

Tolerance class IT16 applies to dimensions in this data sheet unless otherwise specified.

Sensors

Pre-wired Models

E2EF-X2D1 -QX2D1

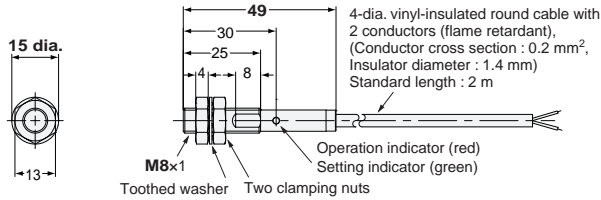

E2EF-X3D1 -QX3D1

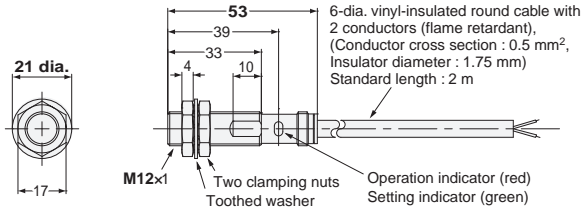

E2EF-X7D1 -QX7D1

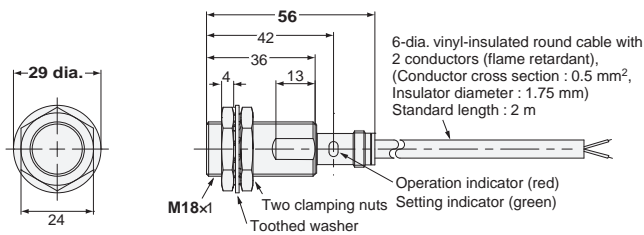

E2EF-X12D1 -QX12D1

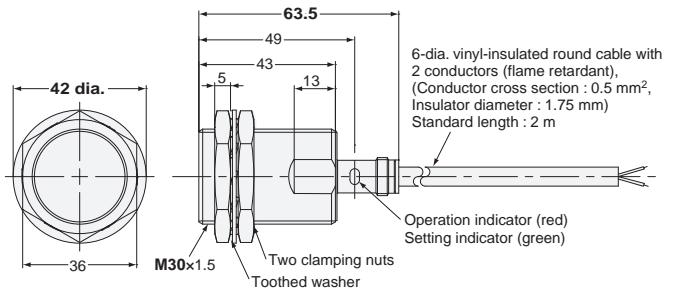

Smartclick Connector Models

E2EF-X2D1-M1TGJ -QX2D1-M1TGJ

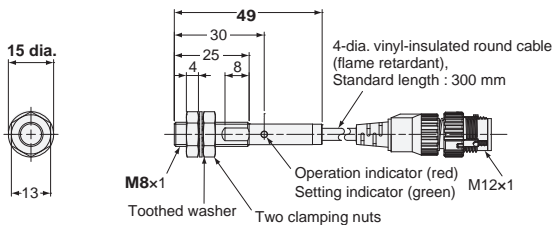

E2EF-X3D1-M1TGJ -QX3D1-M1TGJ

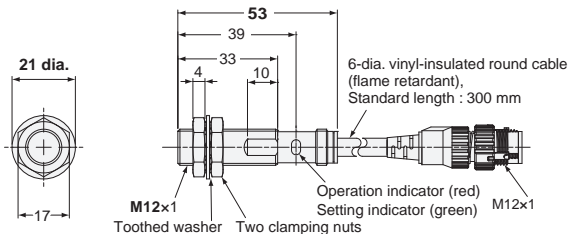

E2EF-X7D1-M1TGJ -QX7D1-M1TGJ

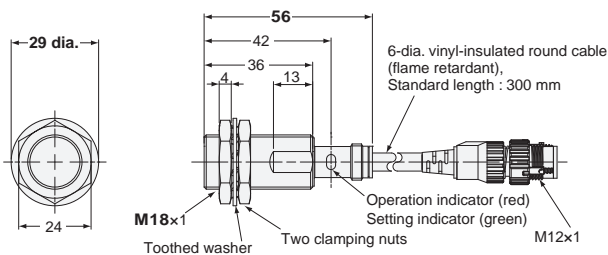

E2EF-X12D1-M1TGJ -QX12D1-M1TGJ

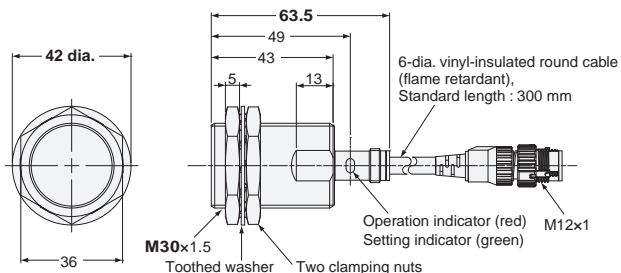

OMRON Corporation Industrial Automation Company
Tokyo, JAPAN

Contact: www.ia.omron.com

Regional Headquarters
OMRON EUROPE B.V.
Sensor Business Unit
Carl-Benz-Str. 4, D-71154 Nufringen, Germany
Tel: (49) 7032-811-0/Fax: (49) 7032-811-199

OMRON ASIA PACIFIC PTE. LTD.
No. 438A Alexandra Road # 05-05/08 (Lobby 2),
Alexandra Technopark,
Singapore 119967
Tel: (65) 6835-3011/Fax: (65) 6835-2711

OMRON ELECTRONICS LLC
One Commerce Drive Schaumburg,
IL 60173-5302 U.S.A.
Tel: (1) 847-843-7900/Fax: (1) 847-843-7787

OMRON (CHINA) CO., LTD.
Room 2211, Bank of China Tower,
200 Yin Cheng Zhong Road,
PuDong New Area, Shanghai, 200120, China
Tel: (86) 21-5037-2222/Fax: (86) 21-5037-2200

Authorized Distributor:

© OMRON Corporation 2012 All Rights Reserved.
In the interest of product improvement,
specifications are subject to change without notice.

CSM_3_1_1014
Cat. No. D113-E1-01

Printed in Japan
0912 (0912) (w)